

# DPV

DCD

FR

EN

**AFFICHAGE ET PILOTAGE SIMPLE POUR DÉBIT, PRESSION, VOLUME**
**DISPLAY AND SIMPLE CONTROL OF FLOW, PRESSURE, VOLUME**

**L'affichage et le contrôle continu des paramètres principaux s'avère bien souvent indispensable pour une bonne conduite des opérations pendant les phases décisives.**

Robuste et lisible, doté d'une interface conviviale de dernière génération, le DPV est une solution efficace et simple d'utilisation pour l'affichage et le contrôle des pressions/débit/volume des pompes.

**The display and the continuous monitoring of key parameters often proves to be essential for proper conduct of operations during critical phases.**

Rugged and readable, with an updated user-friendly interface, the DPV is an effective and easy to use solution for the display and control of pressure / flow / volume of grout pumps.

**JEAN LUTZ SA** - 2 rue du Forbeth - F 64110 Jurançon - France  
Tél. + 33 (0)5 59 06 34 22 - Fax + 33 (0)5 59 06 15 99  
[www.jeanlutzsa.fr](http://www.jeanlutzsa.fr) - [contact@jeanlutzsa.fr](mailto:contact@jeanlutzsa.fr)

## DPV

- Affichage des pressions/débit/volume
- Asservissement des pressions et débit à des valeurs de consignes
- Interface moderne, facile à utiliser
- Enregistrement des données (USB)
- Couplage sans fil (Bluetooth) possible à un Dialog pour des pilotages sophistiqués, consignes variables en temps, centralisation des données.
- Prix compétitif

## DPV

- *Display pressure / flow / volume*
- *Control of pressure and flow following scheduled values*
- *Up to date simple interface, user friendly*
- *Data recording (USB)*
- *Wireless coupling (Bluetooth) possible with a Dialog for an advanced control, schedules variable in time, data centralization.*
- *Attractive price*

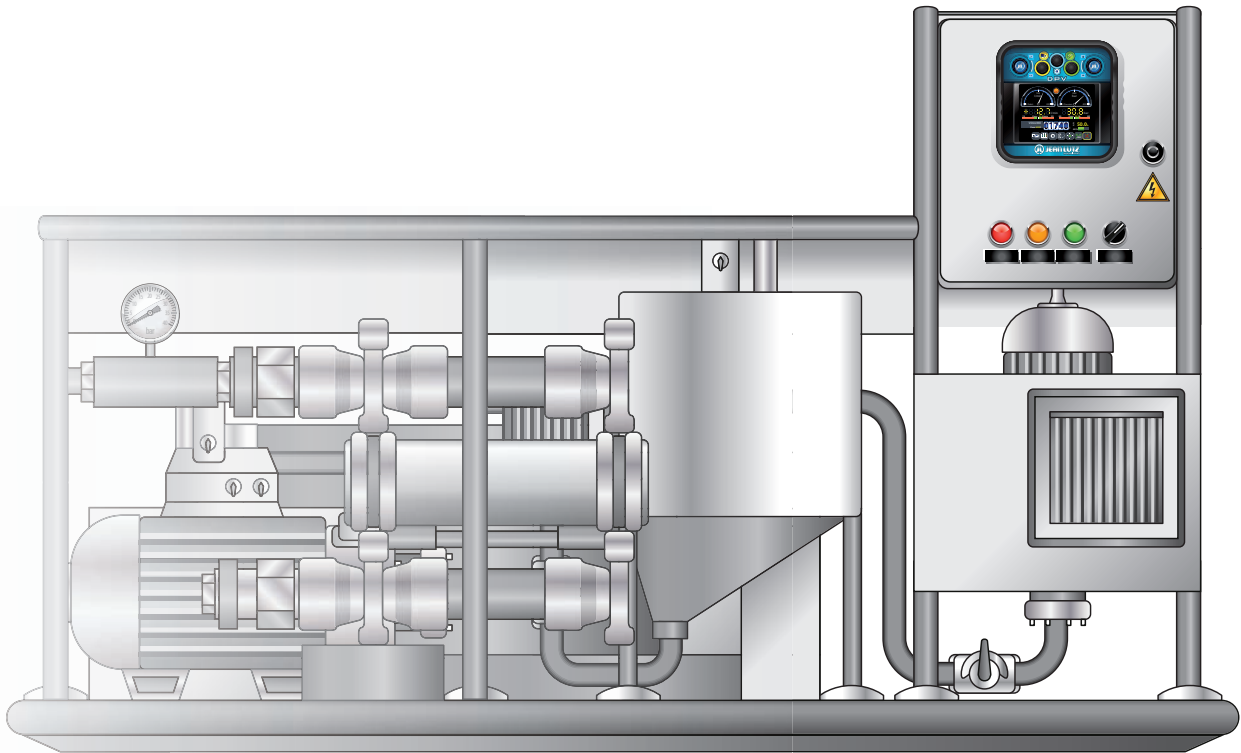

## CARACTÉRISTIQUES TECHNIQUES

## TECHNICAL SPECIFICATIONS

Tension d'alimentation	10-36 V DC - 8 VA max	Power supply
Température d'utilisation	- 20° / 80° C	Temperature range
Poids	2.3 kg	Weight
Étanchéité	IP65	Waterproof
Compatibilité vannes	Courant ou tension de commande / Controller current or voltage	Valve compatibility

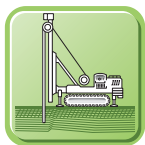

DRAINS  
DRAINAGE

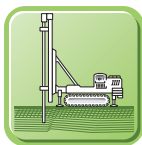

FORAGE  
DRILLING

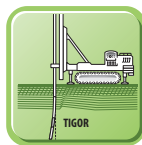

DÉVIATION DES FORAGES  
DRILLING DEVIATION

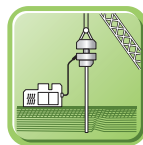

VIBROFONÇAGE  
VIBRODRIVING



GEOTECHNIQUE  
GEOTECHNIC



PIEUX FORÉS  
BORED PILES

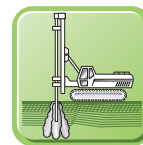

JETGROUTING  
JETGROUTING



INJECTION  
GROUTING



BATTAGE  
DRIVING



PIEUX KELLY  
KELLY PILES

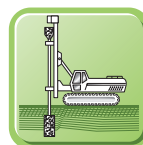

VIBROFLOTTATION  
VIBROFLOTTATION

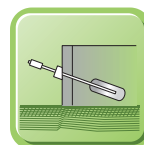

ANCRAGE  
ANCHORING

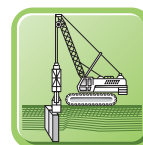

PAROIS MOULÉE  
DIAPHRAGM WALL

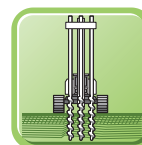

SOILMIXING  
SOILMIXING

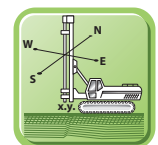

POSITION GPS  
GPS POSITIONING